

$L1 = 2.54 * (\text{No. of pin})$
 $L2 = 2.54 * (\text{No. of pin} - 1)$

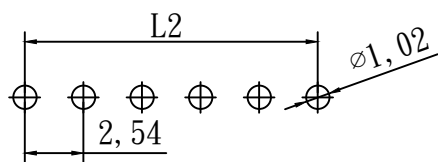
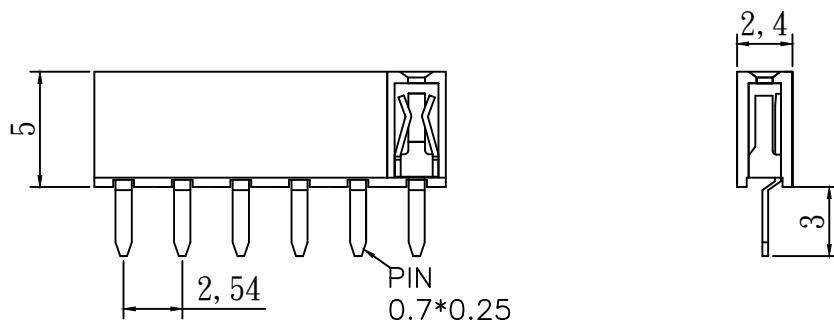

RECOMMENDED P.C.B. LAYOUT

specifications

current rating: 3amp
 voltage rating: 250V ac max
 insulator resistance: 5000 M ohms min.
 contact resistance: 20 m ohms max.
 dielectric withstanding: 500v ac for one minute
 operating temperature: -40°C -- +105°C (ny6t/ny9t)
 max. processing temp: 245±5°C for 3-5 seconds (ny6t/ny9t)

contact material: phosphor bronze
 insulator material: nylon6t nylon9t
 color: black
 finish: gold flash

packing: bag/tray

HOW TO ORDER

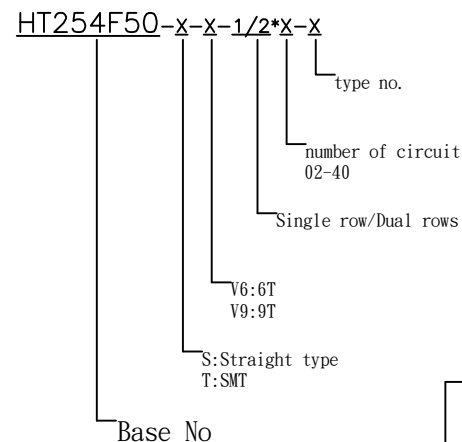

HTE TECHNOLOGY CO., LTD
HTE 興田科技有限公司

CUSTOMER APPROVAL

P/N

HT254F50SX-1*X

UNIT mm

SIZE A4

TITLE

2.54mm female header
single row straight type

GENERAL TOLERANCE
 0.=±0.30
 0.0=±0.20
 0.00=±0.15

SCALE 3:1

REV.

DESCRIPTION

DATE

DRAWN

LILY

CHECKED

SANDY

SHEET 1/1