

HT3001WTS-X-D-C

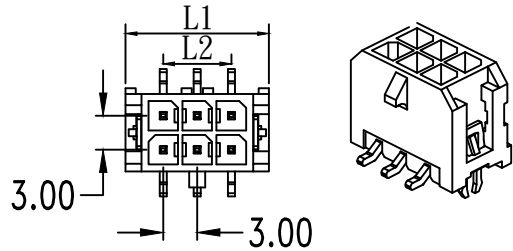

$L1 = 3.0 * (\text{NO. OF PIN} / 2) + 3.65$
 $L2 = 3.0 * (\text{NO. OF PIN} / 2 - 1)$

HT3001WTS-X-F-C

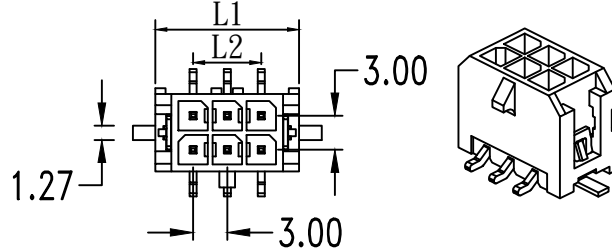

$L1 = 3.0 * (\text{NO. OF PIN} / 2) + 3.65$
 $L2 = 3.0 * (\text{NO. OF PIN} / 2 - 1)$

specifications

- current rating:5A
- voltage rating:250v
- contact resistance:10mΩ max
- dielectric withstanding:ac 1500v/minute
- operating temperature:-25°c--85°c

- mates with :HT3001HM-X housing
- insulator material:LCP
- contact material: BRASS
- color:black
- finish:120u"tin plated

packing:reel

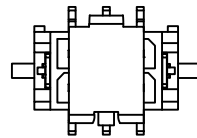
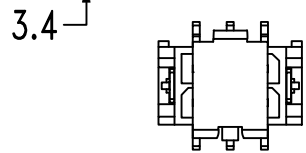
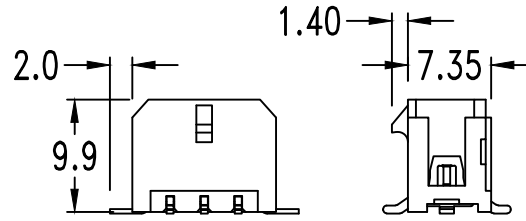
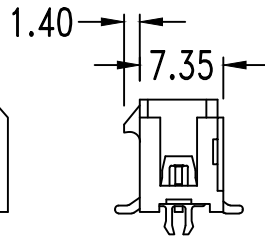

Shown with disposable cap

HOW TO ORDER

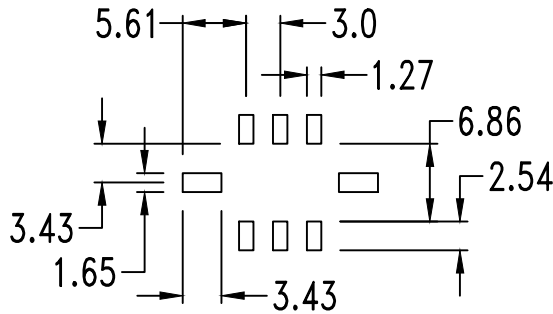
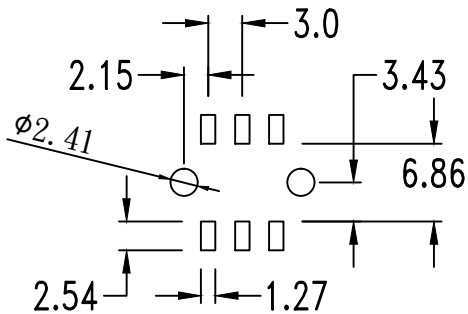
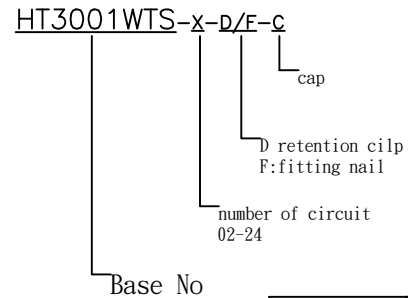

RECOMMENDED P.C.B. LAYOUT

HTE TECHNOLOGY CO.,LTD
HTE 興田科技有限公司

CUSTOMER APPROVAL

P/N

HT3001WTS-X-D/F-C

UNIT

mm

SIZE

A4

TITLE

3.0mm dual rows smt
straight type

GENERAL
TOLERANCE
0.=±0.25
0.0=±0.15
0.00=±0.05

SCALE

2:1

REV.

DESCRIPTION

DATE

DRAWN

LILY

CHECKED

SANDY

SHEET

1/1